

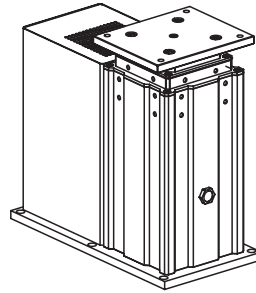

## Telescopic Lifting Units

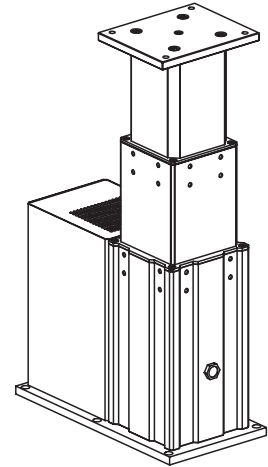

Telescopic lifting unit, retracted



Telescopic lifting unit, extended

### Application

The telescopic lifting units are particularly suited for controlled lifting and lowering in automation as well as for motor-driven height adjustments of assembly fixtures, working tables, supply systems, etc.

### Industry/applications (selection)

- ◆ Automation
- ◆ Drive technology, gears box assembly
- ◆ Couplings, cardan shafts
- ◆ Compressors, pumps, hydraulic elements
- ◆ Industrial fittings
- ◆ Materials-handling technology
- ◆ Automotive industry and their suppliers
- ◆ Machine tool building
- ◆ Building and agricultural machines
- ◆ Electronics

### Advantages

- Good accessibility
- High flexibility
- Improved productivity
- Simple integration
- Optimised ergonomics
- Simple operation
- Short amortisation time

### Description

The telescopic lifting units are equipped with an A.C. motor. Operation is made by the electric machine control or alternatively manually by means of hand or foot control. The compact construction with low height and small width guarantees an unhindered accessibility. The stroke movement is effected by a self-locking spindle drive. The telescopic guide unit consists of a precise aluminium profile section with a pre-stressed plain bearing with low friction and without clearance for exact and sensitive positioning. Mechanical and electric interfaces can be easily integrated in the process of automation.

### Application and installation instructions

The base plate of the telescopic lifting unit must be fixed with 6 screws M 8 of property class 10.9 to a flat level floor or to the connecting structure. For fixing on the floor heavy-duty plugs have to be used and the centre of gravity of the load to be lifted must be within the exterior fixing screws of the base plate. If required, a larger base plate has to be used.

The load has to be placed centrally onto the top plate of the telescopic lifting unit. The max. admissible load moment generated by eccentric loads is 300 Nm. The duty cycle with nominal load must not exceed 20% ED.

### Material

The base and top plates are made of black-oxide steel. The telescopic guide unit is made of anodized aluminium. The protection cap is made of steel, lacquered.



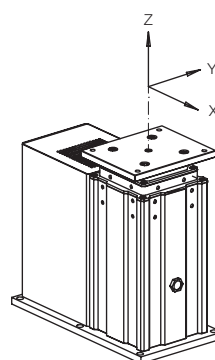
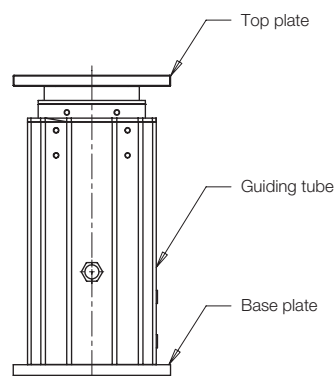
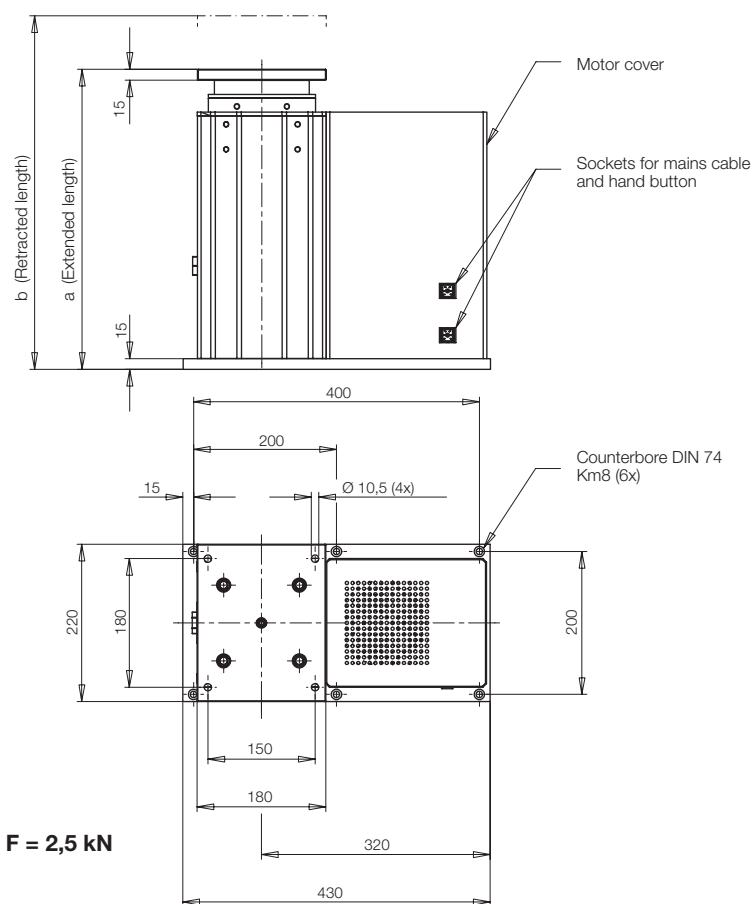

$\Sigma (M_x + M_y + M_z) M = 300 \text{ Nm}$

Stroke	[mm]	340	540	740	940
a	[mm]	420	520	620	720
b	[mm]	760	1060	1360	1660
Lifting force	[kN]	2.5	2.5	2.5	2.5
Lifting speed	[mm/s]	70	70	70	70
Electric connection		1/PE (50Hz, 230 V)	1/PE (50Hz, 230 V)	1/PE (50Hz, 230 V)	1/PE (50Hz, 230 V)
Rating	[kW]	0.75	0.75	0.75	0.75
Control voltage		24 V DC	24 V DC	24 V DC	24 V DC
Duty cycle		20% ED	20% ED	20% ED	20% ED
Code class		IP 54	IP 54	IP 54	IP 54
Weight	[kg]	100	110	120	130
<b>Part-no.</b>		<b>8914-100</b>	<b>8914-110</b>	<b>8914-120</b>	<b>8914-130</b>

### Accessories

#### Operating panels



Hand panel **Part-no. 3823-025**

#### Connecting lines

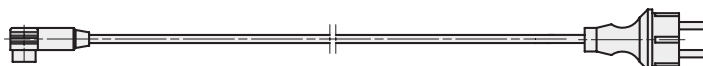

Mains cable 230 V – 3 m long, smooth

**Part-no. 3823-034**



Foot switch **Part-no. 3823-029**

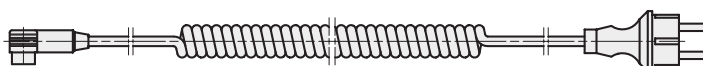

Mains cable 230 V – 1.5m long, coiled

**Part-no. 3823-033**